

HOLMATRO'S VEHICLE EXTRICATION TECHNIQUES



A guide to rescue tool handling and extrication techniques

HOLMATRO'S VEHICLE EXTRICATION TECHNIQUES

By : B. Morris

Head of Holmatro Technical Rescue Training Department

Publisher
éditions
ICONE GRAPHIC

RCS Lille 378 607 964

Important notice

This book contains information on rescue tools and rescue techniques that can be employed in different emergency situations. The situations shown in this book are examples only and are merely meant to assist the user of this book in understanding certain basic vehicle rescue extrication techniques and rescue tools available.

Each motor vehicle accident is unique. Variables such as the type and number of vehicles involved, their positions, number and condition of patients and external hazards all play a role in determining the appropriate actions and their sequence. It is important to note that you should always read and understand the manual for the relevant rescue tools, use the standard operating procedures and follow the instructions of your department and incident commanders.

The extrication scene is inherently hazardous. Your personal safety depends on the training provided by your agency, your use of the appropriate personal protective equipment and your understanding of the rescue equipment you or your agency utilizes. It is YOUR responsibility to read and understand all operation manuals associated with your rescue equipment, receive appropriate training in its use, and ensure that it is properly maintained. Your failure to take all of these steps may lead to death or severe personal injury of victims, yourself or any body else at the emergency scene.

Holmatro disclaims any liability for any damage or injury, whether direct, indirect or otherwise, and whether asserted in contract, tort, warranty or otherwise, incurred as a result of the use of rescue techniques and/or rescue tools described in the book or the use of any other rescue techniques and/or rescue tools that are employed in an actual emergency situation, except to the extent, and limited to, the terms of any warranty provided by Holmatro for its own equipment. Holmatro makes no warranty, express or implied, with respect to its own equipment from the contents of this book, including without limitation, any warranty of merchantability or warranty of fitness for a particular purpose.

Author's note



This guide should be considered an operational extrication text. The goals behind the book are to provide a good basis to the principles of extrication rescue techniques, through the use of clear colourful diagrams and simple explanatory text.

Advanced patient care will not be covered in this book. The reason for this is that I would like to focus on sound extrication principles. Emergency care of the entrapped patient is a subject well covered by many other texts dedicated to this topic. It is however well understood that good patient care during any extrication effort is an important aspect of any successful rescue and it is strongly advised that skills in patient treatment do not go unmentioned in any extrication-training program developed.

This book is by no means the last word on vehicle extrication. It does not represent all the good ideas in the field. It must be mentioned that in all cases of conflict with the content of this book, guidelines from your local authority should be followed. It is not possible to cover every eventuality in the vehicle extrication arena. This text covers certain generic principles that can be used or adapted to every situation. It is also essential that this publication be seen as a resource to complement a good vehicle extrication training course. The techniques described in this text can only be used effectively when practiced after training in a team-orientated manner.

Vehicle Extrication Techniques has been written with the latest developments in vehicle construction in mind. There may be several new approaches covered that are not currently approved or used by your local authority. Like all new extrication techniques it is strongly recommended that they first be practiced by your team in a controlled training environment before being adopted into standard practice. The techniques described in this text have also been performed and developed using the latest advances in extrication rescue equipment and therefore it may be necessary to check the ability of your equipment before going ahead with certain techniques.

Whatever your professional discipline; rescuer, fire fighter, paramedic, law enforcement or military, I trust that you will find studying this book as much fun as I have had writing it.

Brendon Morris

*Head of Holmatro Technical Rescue Training Department
Btec EMC, NDip AEC*

Contents

SAFETY	p.8
- <i>Personal safety</i>	<i>p.9</i>
- <i>Equipment handling</i>	<i>p.10</i>
VEHICLE DESIGN & CONSTRUCTION	p.14
- <i>New car technology</i>	<i>p.15</i>
- <i>Gasoline-Electric Hybrid vehicles</i>	<i>p.18</i>
- <i>Passive safety systems</i>	<i>p.19</i>
- <i>Battery locations</i>	<i>p.22</i>
- <i>Vehicle collision kinetics</i>	<i>p.23</i>
- <i>Specific new vehicle hazards</i>	<i>p.27</i>
- <i>Vehicle construction terminology</i>	<i>p.28</i>
EQUIPMENT	p.30
- <i>Cutters</i>	<i>p.31</i>
- <i>Spreaders</i>	<i>p.32</i>
- <i>Combi-tools</i>	<i>p.33</i>
- <i>Rams</i>	<i>p.34</i>
- <i>Hydraulic pumps</i>	<i>p.35</i>
- <i>Self-contained rescue tools</i>	<i>p.37</i>
- <i>Stabilization equipment</i>	<i>p.38</i>
- <i>Equipment care</i>	<i>p.40</i>

Contents

THE PROCESS

- Crew organization
- Scene safety
- Overview

p.42

p.43

p.45

p.46

BASIC VEHICLE EXTRICATION TECHNIQUES

- Introduction
- Stabilization
- Door removal
- Side removal
- Third door conversion
- Roof removal
- Dashboard roll
- Foot well access
- Dashboard lift

p.50

p.51

p.52

p.57

p.62

p.66

p.68

p.80

p.82

p.84

HEAVY VEHICLES TECHNIQUES

- Heavy goods vehicles
- Buses

p.86

p.87

p.91

ACKNOWLEDGMENTS

p.95

NOTES

p.96

SAFETY



Personal safety

Full personal protective equipment as determined by your agency's standard operating procedures should be worn by all rescue personnel. You must follow the minimum safety requirements found in your rescue tool user's manual.

Minimum recommendations:

- A helmet is essential and should be worn at all times.
- Eye protection (goggles or safety glasses) in conjunction with full face protection (face shield) should be used. A face shield alone does not provide adequate eye protection.
- Protective gloves should be worn at all times.
- Protective clothing should cover the whole body and protect against sharp edges. It is also suggested that this clothing have some fire retardant properties and incorporate reflective material.
- Safety boots with good ankle support and toe protection should be worn.
- Cutting glass and certain composite materials causes the release of fine particles that are hazardous if inhaled. Using a filtration mask when working on these materials is recommended.



Remember that medical oxygen should not be contaminated with grease or oil. Only persons wearing medical gloves should handle these cylinders and regulators and not those rescuers with rescue gloves that may be contaminated with grease or oil.

Equipment handling

It is critically important to read and understand the operator's manual before operating any equipment. Some basic rules to remember:

1. When operating a tool never place yourself between the tool and the vehicle.



2. Because hoses are susceptible to damage (cuts, abrasion, kinks, burns, chemical contamination, etc.) extreme care must be used. Damaged hoses should never be used and should be immediately removed from service.



3. Do not use the hoses to carry, pull or move the tools or pump.



4. Never stand on the hydraulic hose.



5. Components of the vehicle that may be ejected due to cutting or spreading must be controlled.



6. Tools not actively being used should be returned to the tool staging area and left in the "safe" position. (see Equipment Care)



7. Tools should only be carried and operated using the designated handles.



Never place your hands on the arms or blades of any rescue tool.

Equipment handling

A - Spreaders

The spreader is a powerful tool and when used effectively can be very efficient in the extrication process. Spreaders represent a significant crush hazard when used carelessly.

The following points should be noted when using a spreader. The main aspect to consider is correct placement on a stable spreading platform. Once the tool begins to spread it supports most or all of its own weight so that from this point on it is only necessary to support the tool and operate the control handle.

Points to remember:

- Try to always use the full surface of the spreading tips.
- Should the tips start to lose their grip, stop and reposition.
- Ensure that the tool position is such that material is pushed to the outside of the vehicle.
- You cannot prevent the natural movement of a tool during operation. Ensure that you stop and reposition before the tool or parts of your body become trapped against components of the vehicle.
- Never place your hands on the arms or tips of the spreader.
- After working with the spreader it is important to place the tool in its "safe" position (see page 41).



full surface of tips used



correct spreader positioning



spreader carried correctly by handles

Equipment handling

B – Cutters

Cutters are more important on the rescue scene than ever before. This is due in part to advances in vehicle design and construction and improvements in cutter technology. The enormous power available in these tools allows for a significant cutting or crushing hazard when used carelessly.



cutter at 90 degree angle



have good view of cutting

Points to remember:

- Always try to position the cutter so that it is at a 90 degree angle to the cutting surface.
- Ensure that the material to be cut is positioned as far into the blade recess as possible. Avoid cutting at the tips.
- If a cutter begins to twist excessively or you notice blade separation, stop the cut and reposition the cutter.
- Avoid cutting through any hidden airbag inflators or other potential hazards.
- Never place your hands on the blades of any cutter.
- You cannot prevent the natural movement of a tool during operation. Ensure that you stop and reposition before the tool or parts of your body become trapped against components of the vehicle.



material far into blade recess



avoid cutting at the tips

Equipment handling

C - Rams

Rams are an essential part of the hydraulic tool set. It may not always be necessary to make use of them in every case as with a cutter and spreader but they are invaluable in situations where the front of the vehicle is causing entrapment of the occupants. Due to the loads that rams can push and hold, sudden kicking out due to loss of grip is the primary hazard.

Points to remember:

- Always position the ram in such a way that the control handle is easily accessible but will not get in the way later in the extrication.
- If at any time the lifting or pushing operation is stopped pay careful attention to the orientation of the control handle when you begin again. Do not accidentally begin to lower or release pressure on the ram.
- Attention should always be given to both purchase points. If necessary use a ram support to ensure a good secure ramming platform.
- Provide stabilization below the lower purchase point before applying pressure.



control handle easily accessible



good purchase point



use of ram support



relief cut made before ramming starts

VEHICLE DESIGN & CONSTRUCTION



New car technology

The massive developments in the area of vehicle safety construction have meant that both extrication techniques and equipment have had to change in order to keep up with the advances from the motor vehicle industry. In some cases alternative techniques are given in this book. This is due to the fact that every extrication case is different and in certain cases not every approach will be the most effective or efficient. Some of the construction advances found in vehicles these days affect us more than others but the distinct difference in the way vehicles are built now is well noted.



cross section B post model 1996

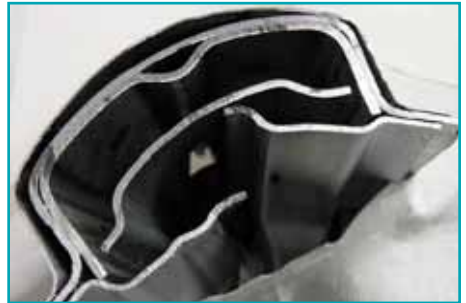

cross section B post model 2002

It must also be mentioned that the techniques portrayed in this guide have been performed specifically with new car technology in mind. Not all tools have the same capability so it is important that you choose the technique that is best suited to the capability of your rescue tool. Bearing in mind that vehicle extrication holds certain risks, it must always be remembered that in all actions taken, the balance between safety and efficiency has to be found. With experience the process of risk identification and mitigation becomes easier.



boron rod reinforcement in dashboard area may affect techniques used for dash lifts



side impact reinforcement bars can lead to door removal difficulties when involved in frontal collisions

New car technology

Unlike understanding human anatomy, understanding the anatomy of safety improvements is a never-ending process. Safety features vary widely from year to year in their design and placement among makes and models. For this reason it is essential for rescuers to know how these safety improvements may affect their day-to-day rescue operations.

1 - Reinforced wheel and engine deflection systems that, in the case of an impact, deflect the wheels and motor under the car away from the passenger cell. Cutting in this area for a dash roll may be difficult.

2 - Crumple zones that absorb the energy of the impact make it possible for occupants of the vehicle to survive collisions they would not have survived a few years ago.

3 - The reinforced dashboard was developed to protect the driver and passengers in case of a frontal or side impact. Conventional one-sided dash rolls may be more difficult.

4 - Micro-alloy and boron steel are used for improved strength-to-weight ratio. Door removal will be more difficult if the impact bars are driven into the frame by impact.

5 - Located in the steering wheel, dashboard, and now any combination of the doors, seats, roof rails and even some seat belt systems, airbags present several challenges. Undeployed airbags may bind up an out-of-date cutter. Knowing which designs are electronically or mechanically activated is critical. Hazards include difficulty in identifying location of bags, sensors and the control module, accidental deployment during rescue, and accidental exposure of wiring or chemicals.

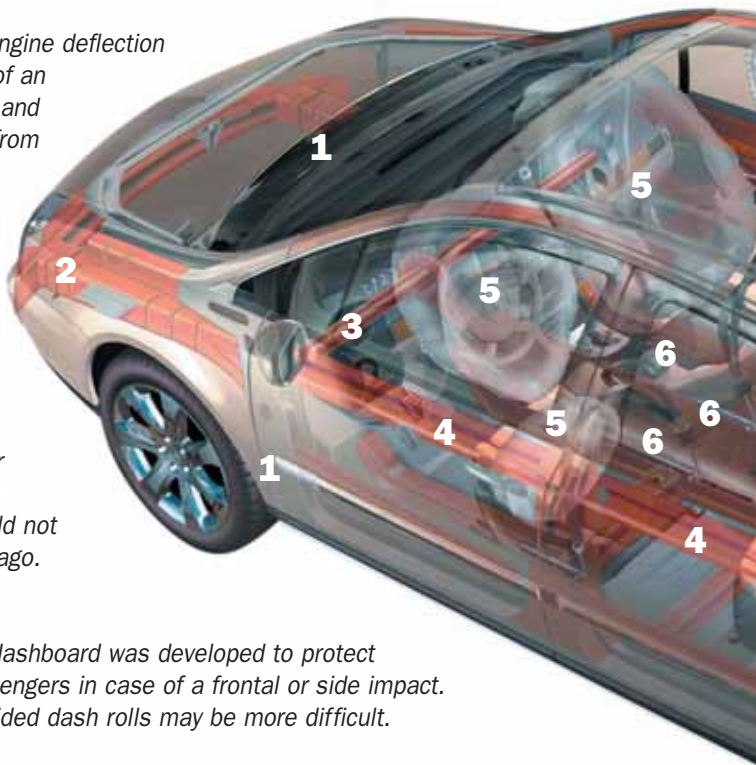

9 - Frame materials – To compensate for weight increase due to added safety features car manufacturers use High-Strength Low-Alloy (HSLA) or even Ultra High-Strength Low Alloy (UHSLA) steel to reinforce roof and pillar structures.

8 - Side and rear window glass – Tempered glass is sometimes replaced in side and rear windows by laminated glass or rigid plastics, which unlike tempered glass, are highly resistant to “breaking” in the traditional sense of the word, and present a formidable barrier in gaining access to patients.

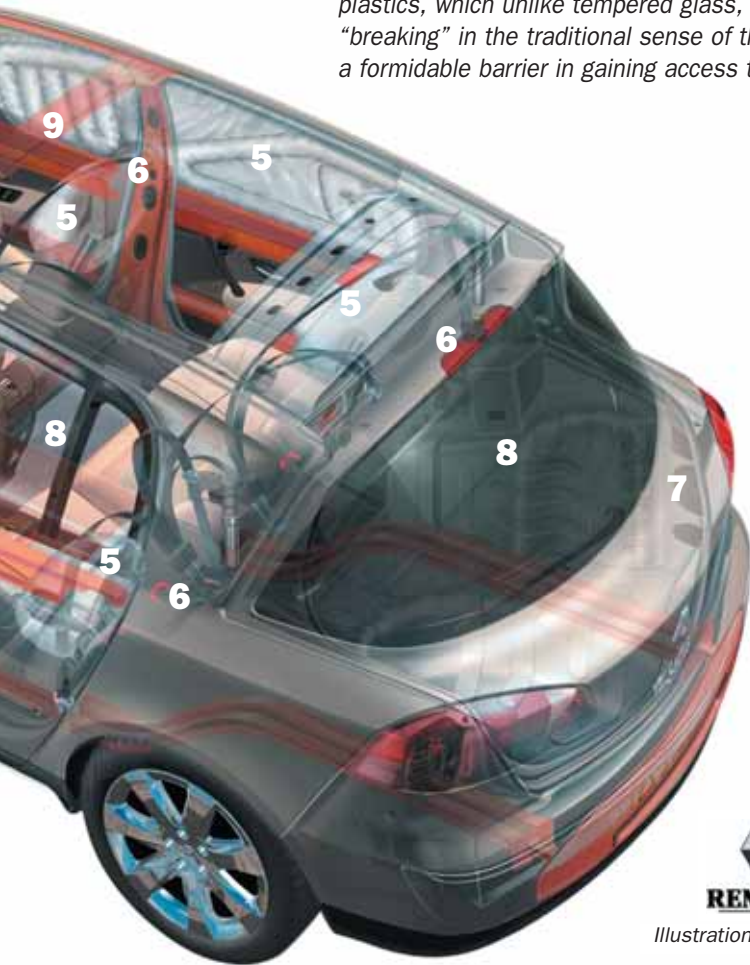

7 - Body materials – High-impact plastic, carbon fibre, aluminum and other composite materials are replacing sheet metal in all or parts of the exterior bodies. Plastic crumples or shatters instead of bending making it hard to find a sufficient purchase point for leverage. Composite materials can be difficult to cut. Carbon fibre is also hard to cut, and both its dust particles and combustion by-products are hazardous.



RENAULT

Illustration : H. Vincent

6 - Seatbelt pretensioners and G-Force limiters are designed to reduce blunt trauma as well as impact with airbags. Seatbelt pretensioners are activated by either a spring mechanism or an explosive charge. Their accidental deployment during extrication can cause serious injury to rescuers and patients.

Gasoline-Electric Hybrid vehicles

Hybrid vehicles make use of both an electric motor and a gasoline engine for vehicle propulsion. Electric power is used for low speed movement and is powered by a high voltage battery pack, typically located in the rear of the vehicle.

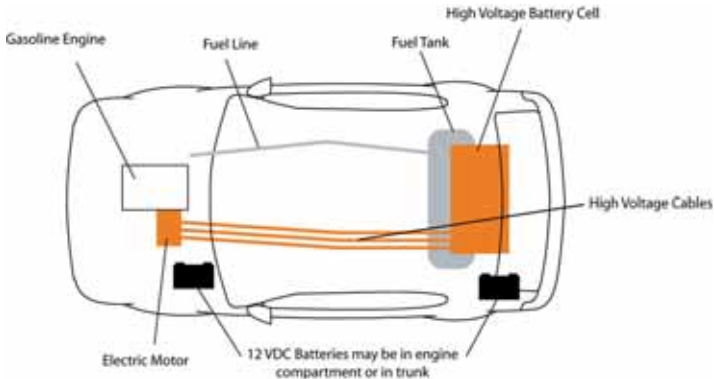

In Hybrid vehicles, high voltage cables are identifiable by orange insulation and connectors. While you need to be aware of these cables, they are routed underneath and inboard the floor pan reinforcement, in an area that is not generally accessed by rescue personnel.

It is important to note that Hybrid vehicles, which may appear to be inactive when the gasoline engine is not running, may still be in the "ready state" and capable of motion at any time. To prevent this from happening, in addition to disconnecting the twelve volt battery, rescue personnel should also check to make sure the main ignition switch is turned to the off position and the key is removed, disabling the electronic drive system.



Never touch, cut or open any high voltage power cable or high voltage components.

Except for the precautions as noted above, Hybrid vehicles may be approached using standard vehicle extrication principles and techniques. Additional information can be obtained from rescuer's guides published by the various vehicle manufacturers.



electronic drive system of Toyota "Prius"



Honda "Insight" battery system

Passive safety systems

A - Airbags

Frontal Impact Airbags: designed to deploy in the event of a frontal impact these bags are commonly located in the steering wheel and various dash board locations. All airbag systems are not alike but do contain similar components. Exact location, volume and mechanism of deployment of the frontal airbag systems varies from manufacturer to manufacturer. Newer frontal airbag systems include the use of dual stage inflators. These dual stage airbags are designed to adjust the force of inflation according to such parameters as occupant position, crash severity, and seat belt usage. If the sensor system dictates partial inflation for the crash, the following are the possible results:

- The first stage deploys, with the second stage deployment occurring within a few milliseconds.
- The first stage deploys, with no deployment of the second stage. This would leave a potential for deployment of the second stage during extrication.
- The second stage deploys, with no deployment of the first stage. This would leave a potential for deployment of the first stage during extrication.



cross section front airbag undeployed



front airbag deployed

Side Impact Airbags: side impact airbags will either be mounted in the door, in the seat edge closest to the door, or in the roof rails (inflatable curtain or tubular type). It is extremely important to avoid crushing areas that contain live airbags, sensors, or cutting through hidden bag inflators.



inflatable air curtain airbag



side impact chair mounted airbag



Simply because an airbag has deployed does not mean that it is safe. Avoid the deployment path of all airbag devices.

Passive safety systems

B - Pretensioners

Pretensioners should be treated with the same amount of caution as you would when working around airbags. Taking the medical condition of the patient into consideration, removal of the seatbelt as soon as possible is recommended. Accidental triggering of the system will then not cause increased injury to the patient. Special consideration should be given to these systems when flammable liquids or vapours are present. There are four main locations for the pretensioning system: lower B pillar, mid B pillar, inner front seatbelt buckle area and rear deck area.



exposed seatbelt pretensioner



low B pillar location



Seatbelt pretensioners can either be mechanically or electrically activated. Use extreme caution when working in the area of seatbelt pretensioners. Several vehicles use mechanically activated pretensioners that have the sensor built into the device. Mechanically activated pretensioners will remain live even after the battery is disconnected.

C - G-force limiters

G-force limiters are built into most seatbelt systems with pretensioners. They allow some leeway in the belt at a certain point in the collision timeline. This decreases the effect of the internal injury by reducing the amount of deceleration and thus the amount of G-force acting on the body.

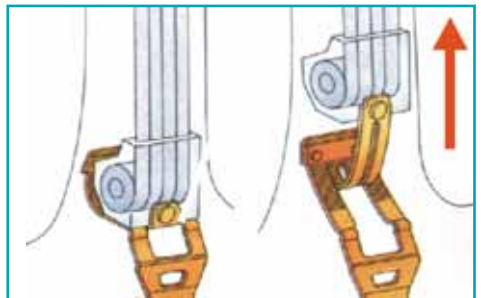

G-force limiter function

Passive safety systems

D - Crumple zones

These are zones in the car body and chassis developed to absorb the impact energy of a collision and to prevent energy from being absorbed into the passenger cell and thus into the occupants of the vehicle.



frontal impact crash test



partial frontal impact

The use of crumple zones has dramatically increased the ability of vehicle occupants to survive massive impacts. Ironically, these very crumple zones that increase survivability can complicate rescue efforts, due to the strength of the deformed metal structures.



full frontal impact



deformation due to crumple zones

Battery locations

The most common battery location is in the engine compartment of most passenger vehicles. However it is important to be aware that some new vehicle designs make use of alternative locations. These alternative locations include but are not limited to the following:

- under the rear passenger seat
- in the trunk (left photograph)
- in the front wheel well (right photograph)



Remember that in some larger vehicles (pickup trucks or utility vehicles) there may be more than one battery on board.



Some manufacturers make use of a device which automatically disconnects the battery in the event of a collision.



automatic disconnection system

Vehicle collision kinetics

A - Tension, flexion, torsion

Metal that is bent (flexion), stretched (tension), or twisted (torsion) requires caution when cutting or spreading as rapid, unexpected movement may occur. The rescuer must understand the mechanical reactions and potential reactions in the body of a vehicle that occurs due to the deformations of the car after a collision.



When talking of a mechanical reaction (impact during the collision that modifies the structure of the car) we will speak of stable points and elastic or unstable points.

To work effectively it is often necessary to eliminate the unstable or potential elastic points in order to avoid an unwanted return of material during cutting or spreading. It is necessary to find the stable points that will serve as a solid base on which spreading tools can be positioned. In cases where there are no hard points, you must create them by installing a support.



ram support acts as stable point

Vehicle collision kinetics

B - Frontal collision

Despite the reinforcement of passenger cell areas in modern vehicles, we must realize that crash tests are performed at relatively low speeds. At higher speeds, much more deformation can occur, complicating the rescue efforts.

Modern safety systems make it more likely that occupants of vehicles will survive major impacts. The challenges that rescuers face in frontal collisions include the reinforced dashboard area as well as the side impact bars mounted in the doors that will very often be pushed backward or forward further jamming the door.



Passenger compartment is significantly compromised resulting in likelihood of more serious passenger injuries.

Less passenger compartment deformation results in likelihood of less serious passenger injuries.

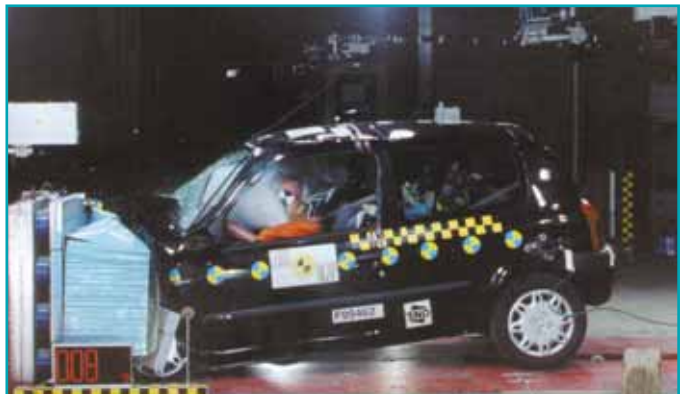

Vehicle collision kinetics

C - Side impact

Side impacts result in high mortality rates as there is so little space between the outside of the vehicle and its occupants. In most cases deformation of the passenger cell results in very little space in which to work around the patient. When possible, concentration of extrication efforts on the undamaged side will often allow for a more effective extrication.



D - Roll-over collisions

In these cases the most important aspect of a good extrication is proper stabilization. Extrication may be further complicated if the occupants of the car are lying in awkward positions or suspended from restraint devices. It is particularly important in this type of crash that movement of the patient is minimized.



Vehicle collision kinetics

E - Under runs and crush incidents

Extremely confined working space and in many cases complicated entrapment make these types of incidents very difficult to handle safely. It should be remembered that good stabilization of the crushing load is paramount and that heavy lifting operations may need to be performed. When performing such a rescue under a heavy vehicle be aware of sprung and un-sprung loads as described in the Heavy Vehicle chapter of this book.



Rescue activities may affect stabilization. For this reason, stabilization must be continually monitored as the extrication progresses. Shoring devices may enhance stabilization efforts.



Photo : Yves Ebel



Specific new vehicle hazards

A – Cutting the seats

Many new design vehicles have airbag components mounted in the seats' upholstery. Airbag sensors, mini gas cylinders, and in some case airbags themselves should not be cut through. To avoid this first always remove the upholstery with a knife to investigate for hazards before cutting through with a hydraulic cutter.



B – Cutting the pillars/posts

Various pillars contain components that should be avoided. Reinforcement for the mounting of the seatbelts can cause damage to cutter blades. Seatbelt pretensioner systems can also damage hydraulic cutters. The most hazardous however is to cut into an airbag inflator. This can be very dangerous as the release of the compressed gas inside the cylinder or fragment of the cylinder itself can cause serious injury.

For these reasons, it is imperative that we always expose and investigate pillars before we cut through them. It is also advisable to use a flexible cutting shield for patient protection during any cutting. This will protect against the tools slipping as well as providing some protection against exploding cylinders in the unlikely event that they have not been seen.



C - Automatic Roll-Over Protection Systems (R.O.P.S.)

These systems deploy as the vehicle begins to roll over. They are typically stowed behind the seats in the rear deck area where cervical spinal management often takes place. This presents a significant risk to rescuers and emergency care providers if deployment accidentally occurs during rescue efforts. Steps to controlling this hazard are disconnection of the battery where possible and avoiding the deployment path.



Vehicle construction terminology

To ensure that everyone understands commands on the extrication scene standard terminology should be used. For example, you should not speak of “left” and “right” but rather “driver side” and “passenger side”. Below are common terms used to describe vehicle anatomy.

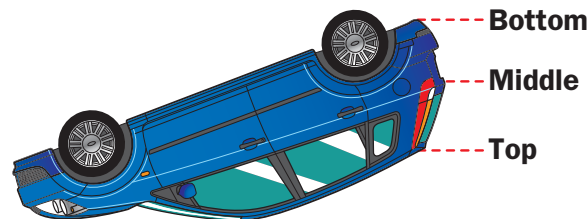
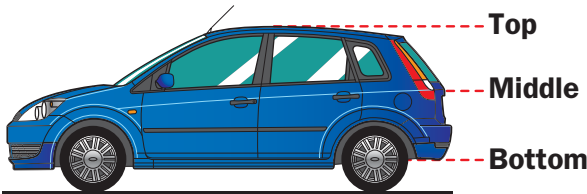
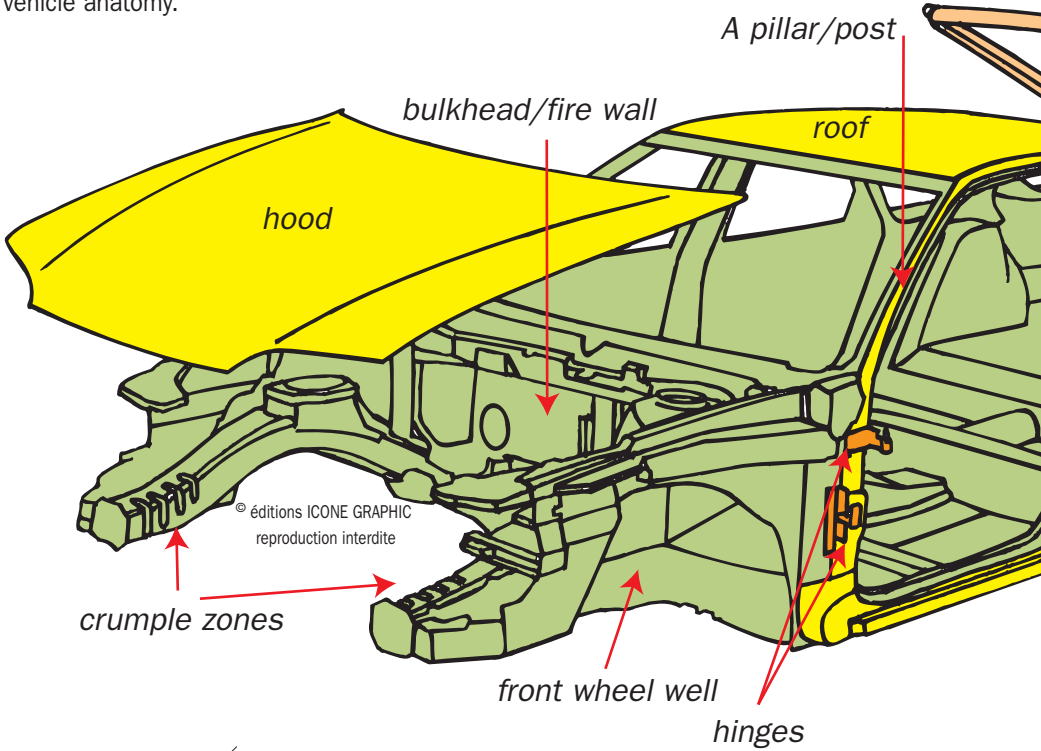

VEHICLE EXTRICATION TECHNIQUES

A Guide to Rescue Tool Handling and Extrication Techniques

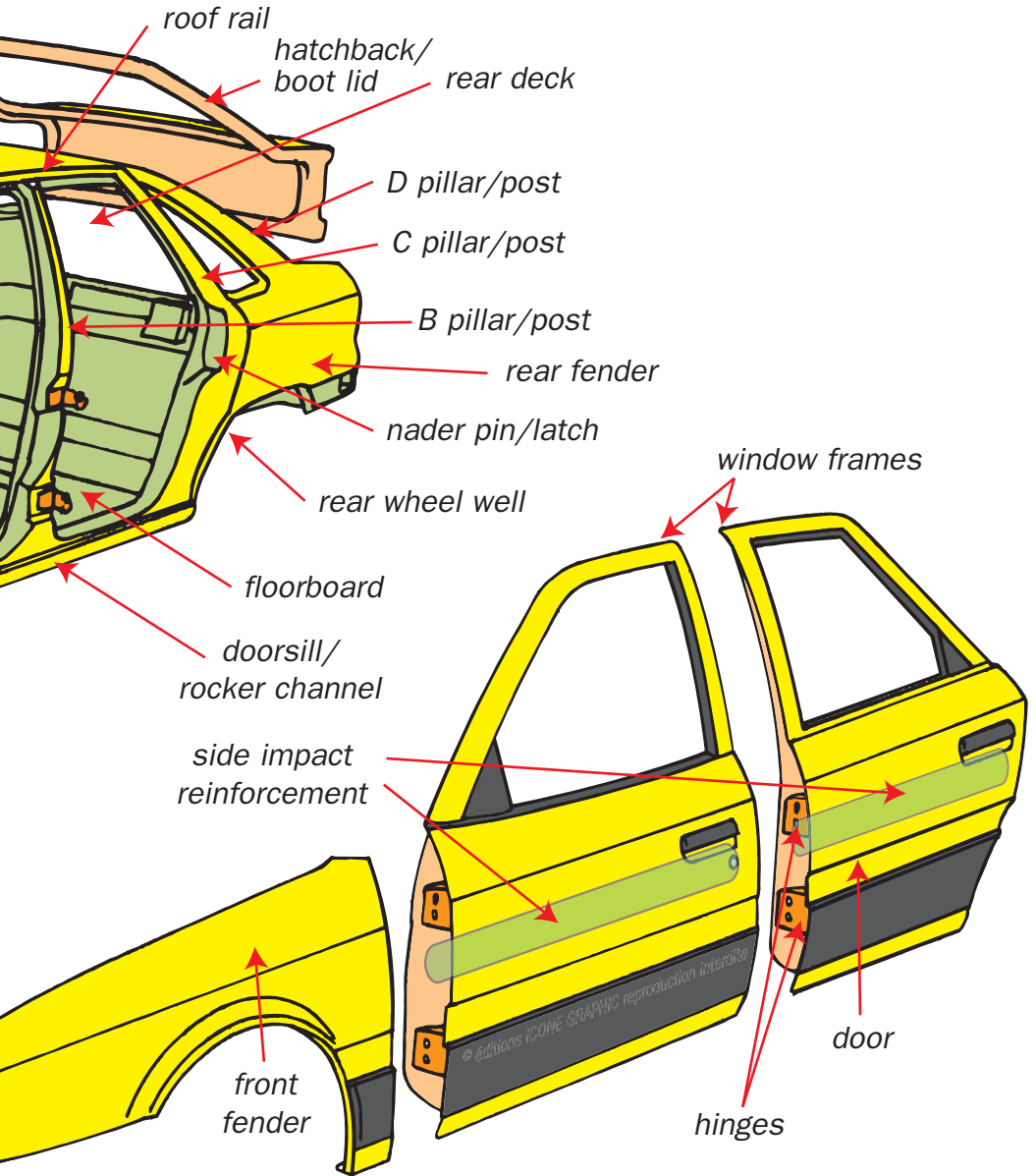

EQUIPMENT



Cutters

Cutters are used to cut through vehicle components in order to remove certain areas of the vehicle. In addition, they can be used to make relief cuts which allow for the displacement of vehicle components as in dash push or roof flapping operations. They are available in a variety of blade designs for different applications.

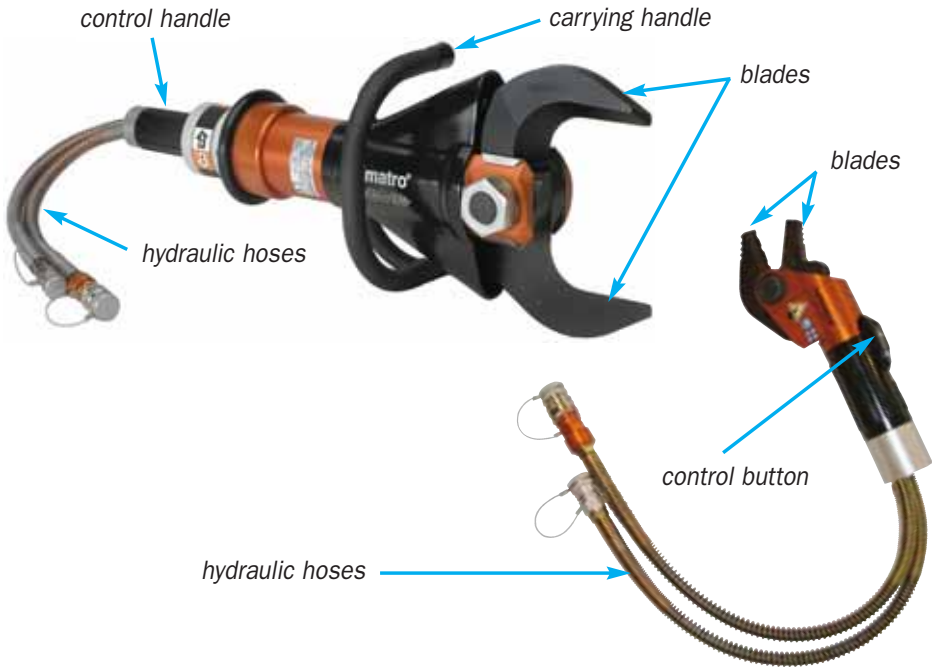

Cutter blades come in a variety of shapes as illustrated below. The various blade types lend themselves to cutting different shapes of material on the car.

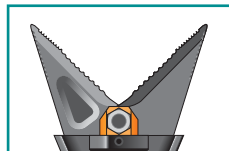
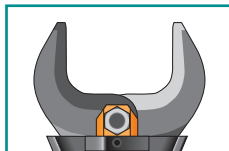

Spreaders

Spreaders have three main functions: spreading, squeezing and pulling. They can crush or squeeze the metal together creating weak fulcrum points or areas for cutting and they can spread components apart. The third function is performed by using chain adaptors on the tips, which makes it possible for the spreader to pull things together.

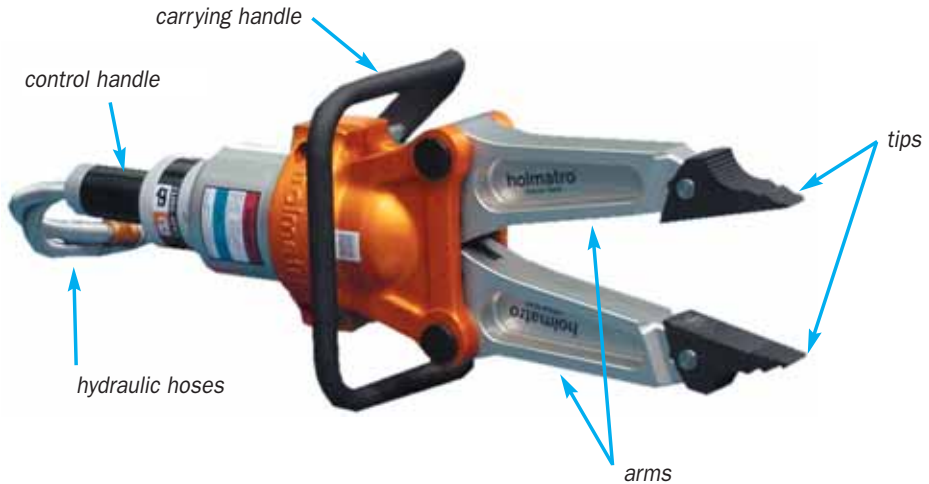

Different shaped tips can be used on the spreader for different applications.



spreading a door from the vehicle



squeezing / crushing a fender

Combi-tools

These versatile tools combine a spreader and cutter in one tool. However, due to the combination of functions, some sacrifices in spreading and cutting abilities are to be expected. As with spreaders, pulling accessories can be used with these tools.

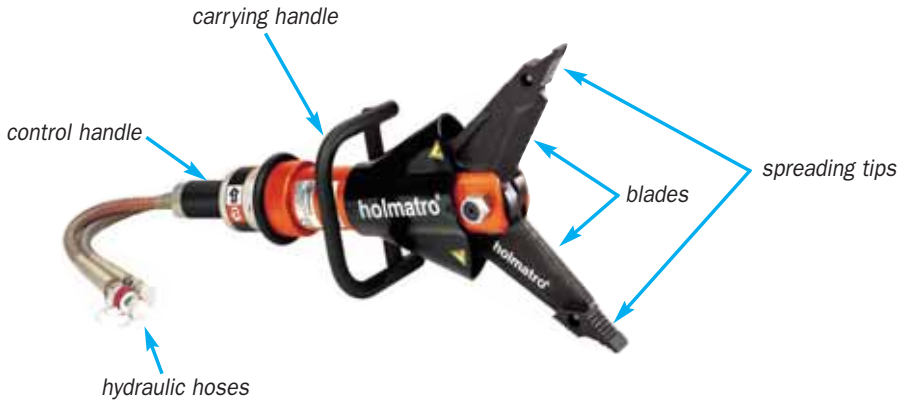

combi-tool used over locking mechanism



spreading a door from the vehicle



dash lift using combi-tool



cutting a C pillar

Rams

Used predominantly for pushing vehicle components apart, rams make use of powerful hydraulic pistons. Some have a telescopic design that makes it possible to have a large ramming length while still being small enough to fit into small spaces. Some rams have replaceable heads making it possible to use accessory tips for other applications like using pulling tips and chains.

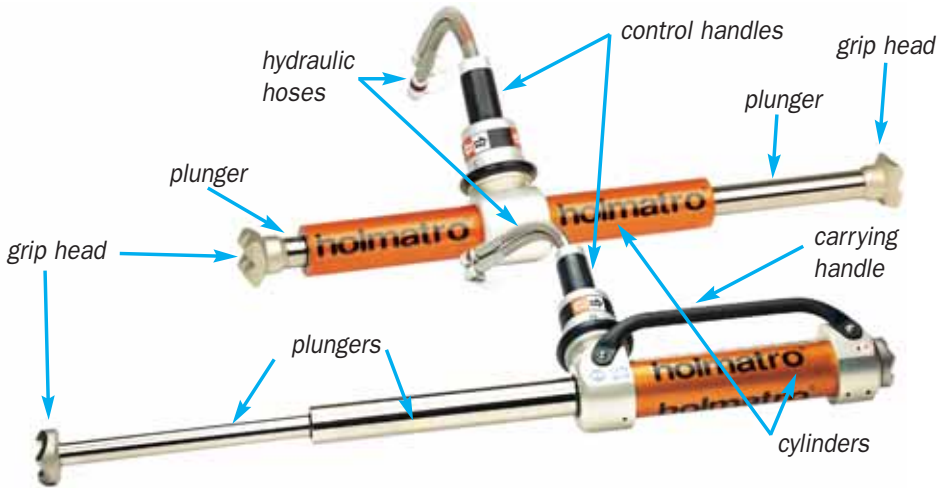

fully extended telescopic ram



good control handle position



ram used for space creation



dash lift using ram

Hydraulic pumps

A - Hand and foot pumps

These hydraulic pumps come in a number of types ranging from simple one-stage pumps to three-stage high volume pumps. They are primarily used as back up pumps or in situations where gasoline driven pumps are not appropriate.



B - Lightweight pumps

These lightweight, compact, gasoline powered pumps are extremely portable. The mobility offered by these pumps makes them ideal for use in remote or hard to reach areas.



Hydraulic pumps

C - Multi use pumps

These hydraulic pumps can be powered by gasoline, diesel or electric motors. They have the ability to run two or more tools simultaneously. Due to their weight, they are generally mounted in the rescue truck but can also be carried away from the vehicle. They can also be supplied with hose storage reels, attached or mounted separately.

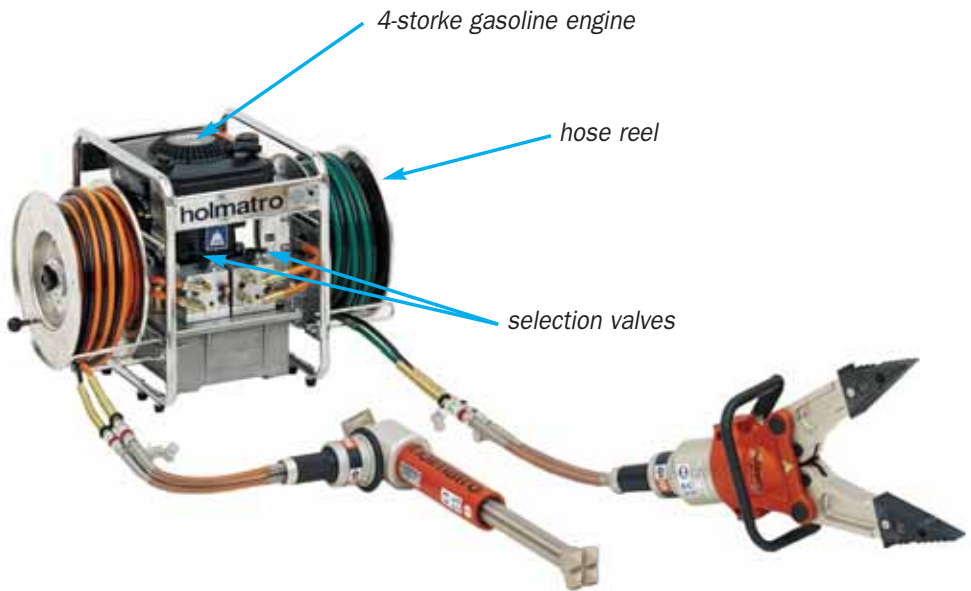

3 tool simultaneous use pump



*lightweight simultaneous use pump
can be carried by one rescuer*

Self-contained rescue tools

These types of rescue tools enable the rescuer to operate in remote and difficult to reach locations such as ravines, and in confined spaces. These tools have multiple applications and are driven by either, rechargeable batteries or manual power.



access to remote rescue locations



manually operated tool

Stabilization equipment

A - Chocks and blocks

They exist in various shapes and are made of wood or recycled polyethylene. Used together they are suitable in all sorts of situations. By bridging the gaps between the vehicle and the ground they are used to increase the stability of the vehicle(s).



B - Lifting bags

Lifting bags should not be considered a primary means of stabilization. Their lifting capacity can be very useful in the stabilization process. However, it is imperative to shore with chocks and blocks as you lift.



low pressure bags

high pressure bags

Stabilization equipment

C - Shoring

Often used where large spaces need to be filled for example when a vehicle is on its side or roof. Shoring devices come in a variety of types, including wood, pneumatic (air) and hydraulic (oil) struts. The more high-tech devices such as air or hydraulic struts, give the rescuer greater flexibility and increased capacity. Air type struts can automatically “follow” the load when lifting while hydraulic struts provide lifting capacity when required.



pneumatic/hydraulic struts



hydraulic struts

All these devices provide stability by making use of a tension buttress system where a triangle of forces is created through the shoring and its tensioning system.



simple mechanical shoring



wood type shoring

Equipment care

To ensure that your equipment is in good working order, it is essential that it is properly maintained in accordance with the manufacturer's instructions. An authorized local dealer should be able to provide periodic maintenance and repair services.

A – Pumps

After each use perform the following checks:

1. Visual inspection for damage.
2. All fluid levels including:
 - a. Fuel.
 - b. Hydraulic fluid.
 - c. Engine oil.
3. Place fuel shut-off valve in OFF/CLOSED position.
4. Couplers should be clean and function correctly. Clean dust caps and put back in place.



check fuel level



replace dust caps

B - Hoses

After each use perform the following checks:

1. Visually inspect for damage:
 - a. Cuts, abrasions or any other damage to outer jacket of hose.
 - b. Kinks.
2. Couplers should be clean and function correctly. Clean dust caps and put back in place.
3. Bend restrictors in place.
4. Clean any contaminant from the hose.



Immediately remove damaged hoses from service.



check bend restrictors



do not use damaged hose

Equipment care

C – Tools

After each use perform the following checks:

1. Visually inspect for damage:
 - a. Cutter blades, spreader tips, ram grip heads.
2. Control handle operation.



3. Pigtail hoses:
 - a. Cuts, abrasions or any other damage to outer jacket of hose.
 - b. Kinks.
4. Couplers should be clean and function correctly. Clean dust caps and put back in place.
5. Tool in safe position (not under pressure):
 - a. Spreaders/Combi-Tools: Tips slightly open.
 - b. Rams: Plunger slightly extended.
 - c. Cutters: Tips slightly overlapping.



plunger slightly extended



tips slightly open



tips slightly overlapping

6. Safety and operational labels are in place and legible.



THE PROCESS



Crew organization

A systematic approach to a vehicle extrication is the best way to ensure that tasks are performed as quickly yet as effectively as possible. The only way to effectively perform a systematic rescue is through teamwork. In order for a team to work in perfect unison they have to know exactly what is expected of them and have confidence in their ability and skills to perform their specific tasks.

The ideal number of rescuers for a simple single occupant entrapment is said to be approximately five to six persons. While numbers in different rescue teams vary considerably from service to service, when using the five person model, we normally split the team into the following roles. The exact title to each of these roles may vary from agency to agency.

1. Incident Commander or Team Leader

This person is responsible for the overall coordination of the rescue team. He or she should whenever possible stand back and ensure they have a good overview of the incident thinking about what steps will come next. In smaller teams this role may have to be performed while functioning in other roles.

The team leader is also the focal point for communication with or from other agencies or teams working on the same scene. In most cases this will be the senior member of the team or the person who has the most experience in dealing with this type of incident.



In many cases this team member also holds the role of safety officer. This is however considered a role all on its own by many teams that have the manpower to support it.

2. Technical team member 1

This member of the team works together with technical team member 2 having the bulk of the actual rescue skills required for making the scene safe and freeing the entrapped victims.



3. Technical team member 2

Works together with technical team member 1. This team position is based upon availability of manpower.

4. Equipment coordinator

Normally this is the driver of the rescue unit. This rescuer's tasks include preparing and staging equipment required for use by the technical team. When situations present themselves in which the technical team requires help, particularly in terms of manpower, the team leader may call the equipment coordinator in to help the technical team.

5. Patient attendant

The medical assistant will stay, from the earliest opportunity, in constant contact with the patients entrapped, informing them of exactly what is happening during the rescue. This rescuer will assist the emergency care providers during the rescue process. If the emergency care team does not require this rescuer at any point, he or she will then become available to assist the technical team wherever necessary.



Scene safety

To promote a safe and organized rescue scene it is important that rescue zones be established. The first zone or sector called the inner circle or action area is an imaginary circle with a radius of approximately 3–5 m/10-15 ft around each vehicle involved. This area should be kept clear of anybody not directly involved in the rescue at that time.

The second zone is a larger circle measuring 5-10 m/15-30 ft. This area should be kept clear of all non-rescuers and may even be cordoned off if circumstances permit. It is in this area, bordering the inner circle, that a tool staging area should be set up. In this way everyone involved knows where to find the tools and can keep the action circle clear of equipment not being used. A parts dump where components removed from the vehicle(s) during the rescue are placed, should be established just outside of the second zone. These steps allow for a more efficient and safer working environment.

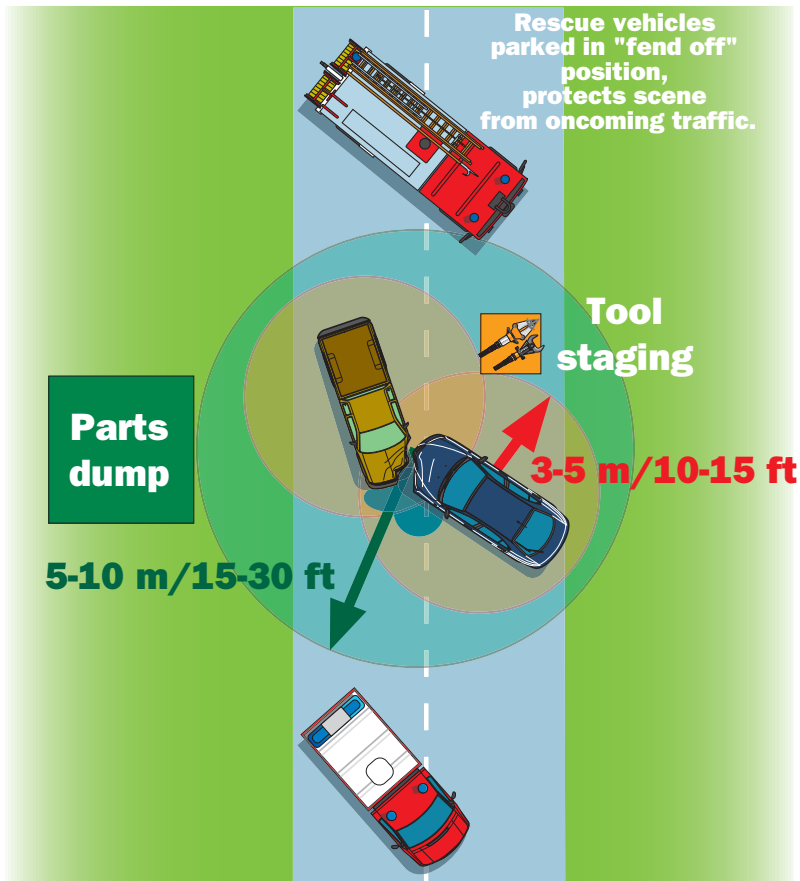

Overview

SAFETY POINT:

Have fire protection on hand.



Initial approach:

Wherever possible the initial approach should be as follows:



OBJECTIVE:

Assessment of the scene for any hidden hazards making the vehicles involved safe to work on, in and around.

These are the steps which should be followed before beginning extrication operations.



Wherever possible the rescue team's approach should be from the front of the vehicle involved. This ensures that any lucid victims in the vehicle are less likely to turn their necks to make contact with the approaching rescuers. Once contact has been made with any patients inside, this contact should not be broken until management of the patient is handed over to an emergency care team member.



Technical team members may now move around the involved vehicles making assessments above, below and around the vehicle for any hidden hazards such as powerlines, fluid leaks or other patients. Report findings to Incident Commander who will determine if any hazard mitigation steps are necessary.

Overview



Once a full assessment of the vehicle has been completed and hazards dealt with, the vehicle should then be stabilized. This will be covered in more detail under the stabilization chapter of this book.



The vehicle ignition should be switched to the full “off” position at this time and the battery disconnected. It is important that the negative terminal is disconnected first to remove the chance of sparks caused by inadvertently grounding the positive terminal.

Remember to make use of electric windows, locks and seat options before disconnecting the power supply completely. Where possible, the emergency brake should be engaged.



When battery can not be disconnected, leave the hazard lights on as a warning for all rescuers.



Any occupants of the vehicle should be protected before breaking glass. It may be necessary to have a rescuer on the inside of the vehicle to help with this protection.

Overview



Glass management should now be performed. Remember that all glass that may break during future rescue efforts should be removed at this time.

This can be performed with the use of a window punch or, if need be, a glasscutter. Certain new cars are now fitted with

Enhanced Protection Glass (EPG). If it is not possible to remove glass by standard controlled breaking and cutting systems, it may be necessary to leave the glass in place.



Glass removal after use of the window punch should be from the inside out. In some cases it is advisable to have the window rolled down into the door before it is broken. You may, however, need the battery connected to do this.



If crew size permits, small glass debris should be swept under the car or out of the action circle.

Overview



In some cases glass management is necessary to access the patient. If this is the case, always first break the glass furthest away from the patient. Once the patient has been accessed initial assessment and emergency care can be given, including spinal immobilization and supplemental oxygen.



Cut or remove, in consultation with emergency care team, any seat belts as soon as possible.



Wherever possible, avoid the deployment path of airbags. If your agency uses a driver's side protective airbag cover, install it now.



A trained step-by-step approach is the key to achieving this section of the rescue safely and effectively. Actions taken here lay the groundwork for the safety of the rest of the rescue.

BASIC VEHICLE EXTRICATION TECHNIQUES



Introduction

The bulk of motor vehicle collisions with entrapment involve light motor vehicles. The term light motor vehicles is becoming harder to define. When we use this term we are referring to mostly privately owned passenger vehicles such as the family car. The biggest irony is that these “light” vehicles now incorporate advanced construction designs and materials that while providing greater survivability to the patients present more difficulty to the rescuer.

Each motor vehicle crash is unique. Variables such as the type and number of vehicles involved, their positions, number and condition of patients and external hazards all play a role in determining the appropriate actions and their sequence. This section will cover basic techniques that can be used to perform safe vehicle extrication and should become second nature. Like any skill these techniques require practice.



Stabilization



OBJECTIVE:

To minimize movement of the vehicle, that may negatively affect entrapped patients or injure rescuers.



ATTENTION:

This part of the rescue should be performed properly before any other extrication efforts are started.

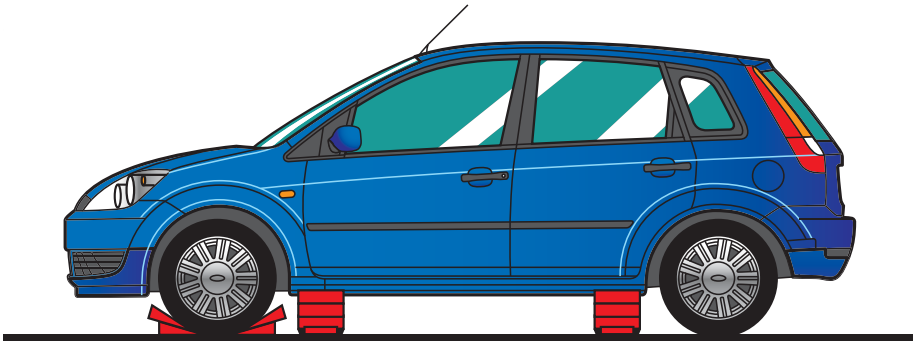

3 point system

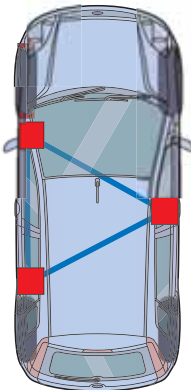

4 point system

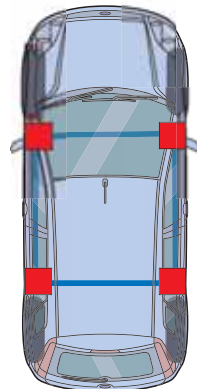

A - Vehicle on its wheels

A minimum of three points of stabilization may be used but four points, if possible, are strongly advised. Stabilization blocks should be strategically placed to ensure maximum stability, as seen in the diagram.

Stabilization

THE PROCEDURE:



The first step is to double chock one or two of the wheels.



Stabilization blocks should be secured in place by wedging with only enough pressure to ensure that they are snug.



When using step chocks, a wedge can be used to secure the chock. An inverted step chock may also work.



Stabilization

B - Vehicle on its side

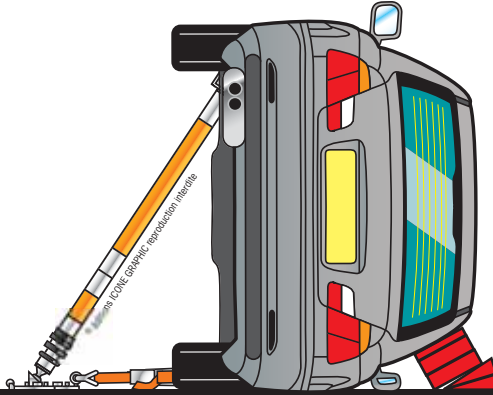

THE PROCEDURE:



To ensure that the vehicle does not fall over, support it under the A and C pillars.

Think ahead, avoid placing stabilization in areas where you are likely to cut.



Shore the bottom side with mechanical struts (wood, metal), or with hydraulic or pneumatic struts.



Stabilization



Fasten the struts in place by using the tension belts or mechanical mechanism.



On mechanical struts it may be necessary to use wedges to ensure a secure fit.



Depending on the situation it may also be necessary to use shoring to stabilize the roof side of the vehicle.

Stabilization

C - Vehicle on its roof

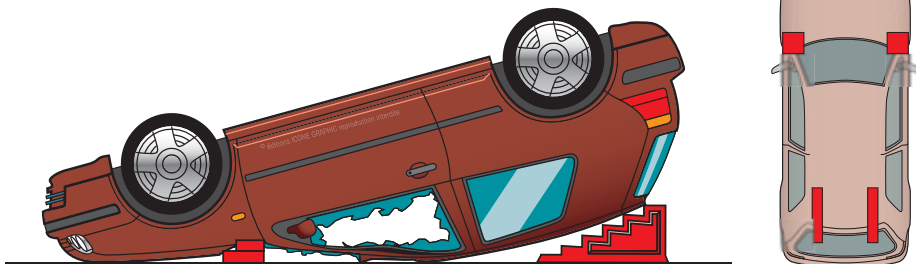

THE PROCEDURE:



Chock the space between the back of the vehicle and the ground.



Add additional blocks to the space between the engine compartment and the windshield for added stability.



Door removal

A - Vehicle on its wheels



OBJECTIVE:

To gain access to the patient in order to allow for better care during the extrication. This opening may also be used for immediate release if appropriate.



SITUATION ASSESSMENT:

The most appropriate door removal technique will depend on the type and nature of structural damage to the vehicle as well as how the trapped patient is affected. Remember the first step may be to unlock the door and to open it normally if possible.

THE PROCEDURE:



When there is no insertion point for the spreader and the front fender is accessible, first squeeze this panel on the highest point of the wheel well. This will create an opening over the hinges of the door.



Door removal

THE PROCEDURE:



If the fender needs to be further removed make a relief cut where it is squeezed.



The panel may now be further removed with the spreader. Be careful while spreading the panel as it may suddenly release from the body.



Making use of a stable spreading point above the top hinge, the door may now be spread away from the vehicle.



Only attack one hinge at a time. Do not begin between the two hinges.



If your purchase points begin to tear, stop and reposition your spreader or cut the hinges.

Door removal



After the hinges and the small strap between them are broken or cut the next step is to remove the door from the lock side.



Once a door has been completely removed it should be placed in the designated parts dump.



ALTERNATIVE:

The nature of the accident may make the front part of the car inaccessible. In this case exposing the hinges may be achieved as follows:



Place the spreader in the front corner of the windowsill. Spread against the A pillar to create an insertion point over the hinges.



To avoid the spreader being pulled into the patient compartment, ensure good tip placement and angle of the spreader.

Door removal

B - Vehicle on its roof



THE PROCEDURE:



Squeeze the rocker channel in order to create enough space for the tips of the spreader.



If necessary, increase the opening by pinching the metal of the bottom of the door and folding downward.

Door removal



Spread the door outwards away from the body.



Once the door is open after breaking away from the lock, cut or spread the hinges and remove it.

ALTERNATIVE:



Use the tips to pinch and make an opening on the lock side.



Use the spreader to break the lock mechanism by spreading the door away from the body and continue with removal as described above.



Always control the movement of the door ensuring that it does not come into contact with the patient or with the rescuer or push against the ground causing the vehicle to move.

Side removal



OBJECTIVE:

Creating a larger opening in the side of the vehicle that can be used for patient care or immediate release if appropriate.



THINK AHEAD:

It may not be advisable to use this technique if a dashboard roll is going to be required later.

THE PROCEDURE:



First remove the front door using one of the techniques previously discussed.



Remove the back door by cutting or spreading the exposed hinges.



Side removal



Cut the top and bottom of the B pillar to remove it. Remember to use sharp edge protections.



Expose and investigate all pillars or roof rails before cutting.

ALTERNATIVE:



Starting at the back, squeeze the door in order to create an insertion point for the tips.



Now spread the door until the lock fails and the door opens.



Always control the movement of the door ensuring that it does not come into contact with the patient or with the rescuer or push against the ground causing the vehicle to move.

Side removal



Working in the back door opening make a deep relief cut in the lowest part of the B pillar to weaken it.



Expose and investigate all pillars or roof rails before cutting.



Set one of the tips of the spreader on the base of the back seats or rocker channel. Open it slowly while watching the stability of the support point and position the other tip against the lowest part of the B pillar. Now spread the pillar outwards tearing it from the sill.



Continue the spreading by repositioning the spreader tips until the B pillar is separated from the sill or enough room has been created to complete the operation with a cutter.

Side removal



Remove the B pillar by making a cut at the top of the pillar as high as possible.



Expose and investigate all pillars or roof rails before cutting.



Remove the front door from its hinges while other rescuers support the doors.



Ensure good sharp edge protection.

Third door conversion



OBJECTIVE:

Creating an opening of the side of a two door vehicle that can be used for patient care or immediate release if appropriate.



THINK AHEAD:

It may not be advisable to use this technique if a dashboard roll is going to be required later.

THE PROCEDURE:



First remove the front door using one of the previously discussed techniques.



Make a deep relief cut at the base of the B post. If necessary squeeze this area first to help with the cut.



Expose and investigate all pillars or roof rails before cutting.

Third door conversion



If the B post extends to the roof, cut through the top of the B post.

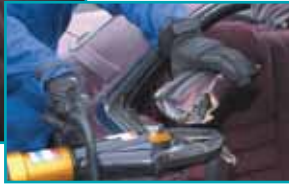

It may be safer to remove the B post completely.



Make a vertical relief cut in front of the C pillar.



Position the spreader tips into the relief cut at the base of the B pillar. Open the spreader to push the panel out and away, creating the third door.



Space created by this technique after ensuring good sharp edge protection.

Roof removal



OBJECTIVE:

To remove the roof structure, in order to allow greater patient access and extrication from the vehicle when appropriate.



SITUATION ASSESSMENT:

The most appropriate roof removal technique will depend on the type and nature of structural damage to the vehicle as well as how the trapped patient is affected.

Depending on the nature of the impact and the environment of the accident, it is not always necessary to remove the roof completely. Other ways of dealing with a roof are:

- forward roof flap
- backward roof flap
- partial roof flap
- side roof flap
- inverted roof flap

Each of these techniques has its own advantages and disadvantages that have to be evaluated when deciding which will be best in any given situation.

Roof removal

A - Full roof removal

THE PROCEDURE:



Remove all necessary glass as discussed earlier.



Cut both A pillars.



Cut the windshield from one side to the other providing protection for both patient and rescuer from glass fragments and glass dust.



Cut both B pillars.



Rescuers should fully support roof before any pillars are cut.

Roof removal



Continue by cutting the C pillars.



Expose and investigate all pillars or roof rails before cutting.



With the roof supported make the final cut ensuring that there are no other points of attachment such as seatbelts or plastic trim.



The rescuers can now lift the roof and carry it to the designated parts dump.



The final step is to ensure that all sharp edges are covered.

Roof removal

B - Forward roof flap

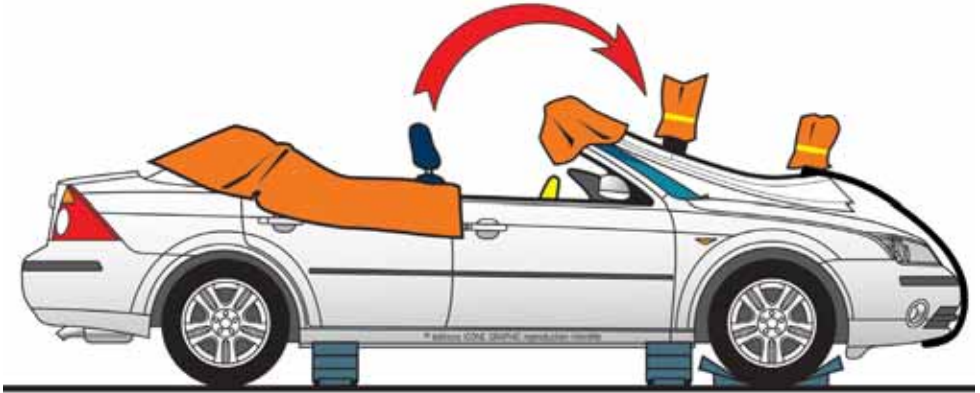

THE PROCEDURE:



First cut the B and C pillars. This should be done while other rescuers support the roof.



After ensuring that adequate glass protection is in place, make relief cuts on both sides of the roof just behind the windshield.



Roof removal



Rescuers may now fold the roof forward. It may be necessary to use a bar to assist in the folding.



A strap must be used to secure the roof in its folded position.



Sharp edges should be covered.

Roof removal

C - Side roof flap



Stabilization should be in place before beginning any extrication efforts. This is especially important when the vehicle is in such a precarious position.

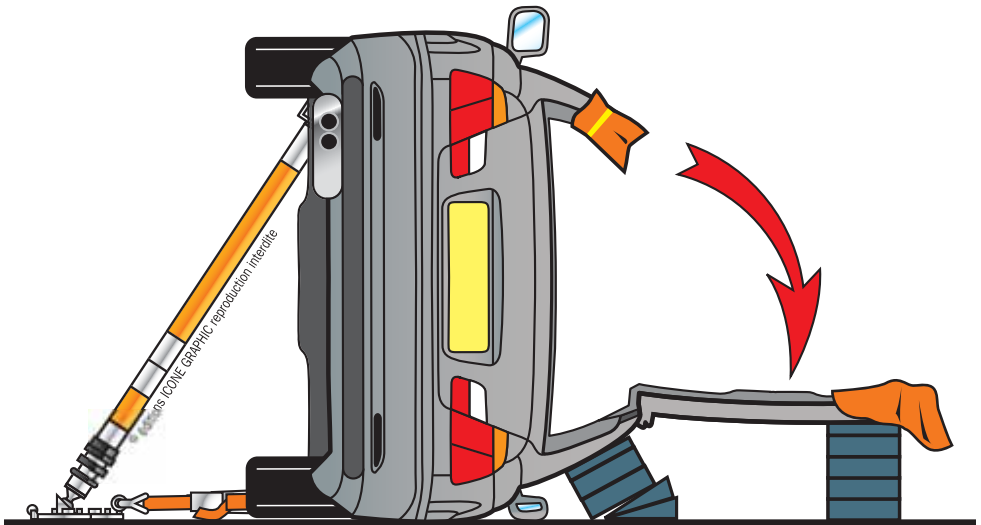

THE PROCEDURE:



Cut an opening in the A pillar.



Roof removal



Cut the windshield at an angle as indicated in the picture to create a hinge point. Remember to protect both patient(s) and rescuer(s) from glass fragments and glass dust.



Cut the B pillar close to the roof.



Cut the C pillar as close to the roof as possible.



Roof removal



Make a relief cut in the roof just above the C pillar. In some vehicles the construction is such that it will require a relief cut above the A pillar as well.



To create a horizontal working platform place shoring blocks where the roof will lie. Fold the roof downward as smoothly as possible to avoid destabilizing the car.



The final step is to ensure that all sharp edges are covered.

Roof removal

D - Inverted roof flap



It must be mentioned that this method requires a well trained rescue team that has practiced this technique together.

This technique is also commonly referred to as the “Oyster” or “Clamshell” technique.

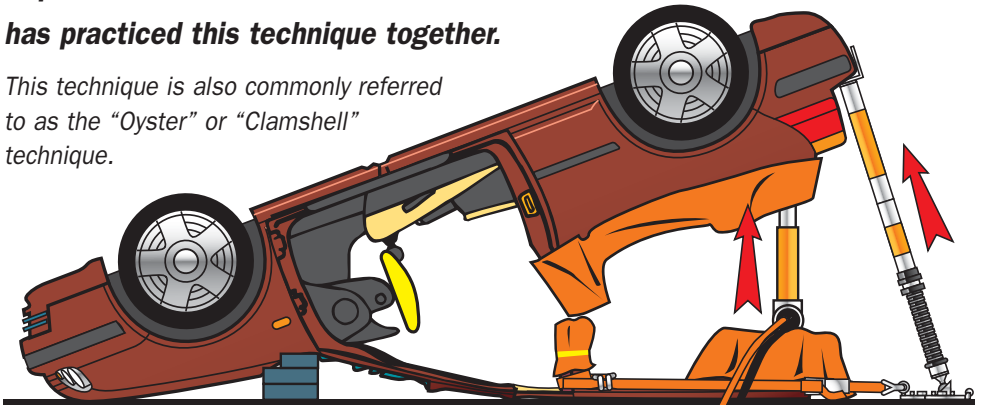

THE PROCEDURE:



Stabilize the vehicle using chocks and blocks as previously discussed. Remember that the vehicle pictured in this exercise has front engine weight. Other rear engine vehicles will need to be approached differently. If your agency uses a driver’s side protective airbag cover, install it now.



After stabilization, standard glass management should be performed.

Roof removal



Open the rear of the vehicle by removing the hatch door if possible.



Shore the back part of the vehicle and put the struts under tension.



Remove the back seats of the car in the case of frontal occupant entrapment. This will allow better patient access. In some situations, this may not be possible without first creating more working space.



If you intend to flap the roof down, remove the chocks from under the roof. If not, continue the procedure with them in place, to prevent the roof moving downward.

Roof removal



Position a ram on a stable support point on the roof and put it under pressure between the roof and the vehicle floor.



Now cut the B and C pillars on both sides taking the standard precautions.



As the pillars are cut it may be necessary to adjust the ram to ensure it remains in place under pressure.



Throughout the process of cutting, lifting and stabilizing, a coordinated approach must be used.



Depending on the chosen approach at this point, you will either lift the vehicle or push the roof down using the ram.

Roof removal



As space is created using the ram. The shores should be continually adjusted to ensure they provide optimal stabilization.



The struts are only installed to support the vehicle. They should never push it upwards as this may cause the ram to fall out of place.



When the procedure is completed there is ample room for allowing a controlled release of the patients.



Space creating techniques can be used in various ways to create a clear working area or allow extrication of entrapped patients.

Dashboard roll

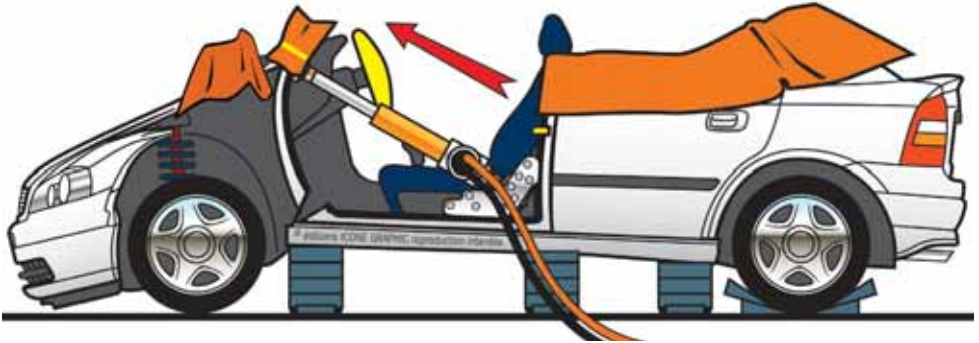

OBJECTIVE:

To displace the dashboard in order to aid extrication or gain access to the feet.

The technique of pulling the steering wheel with a spreader and pulling chains is no longer advised. The forces on the steering column may cause breaking of the joints thus injuring rescuers and patient(s).



Dashboard reinforcement in newer vehicles may require the use of a ram on each side of the vehicle. Extend both rams simultaneously to counter the effect of downward displacement caused by this rigid construction.



THE PROCEDURE:



Stabilize the vehicle as previously discussed. Add additional stabilization directly below the B pillar where the base of the ram will be placed. While not every situation will allow it, the use of a ram support is strongly advised to distribute the force exerted at the base.



Dashboard roll



Position the ram and secure it in place using a small amount of pressure. This will prevent the dash from dropping due to the relief cut. Be sure to position the control handle outwards and not upwards.



Make a relief cut through the base of the A pillar. Where space is limited, it may be necessary to make this cut before positioning the ram.



Pay careful attention to movement of the cutter during this operation to ensure that it does not make contact with the patient, the seat or the ram.



Controlled ram extension may now begin. Be sure to monitor all purchase points during this operation. Remember to check stabilization throughout this procedure, making any required adjustments. Use wedge blocks in the opening of the relief cut.



If at any time the operation is stopped pay careful attention to the orientation of the control handle when you begin again. Do not accidentally begin to lower the ram.

Foot well access



OBJECTIVE:

To create greater access to the foot well to aid in disentanglement or patient care.



SITUATION ASSESSMENT:

In severe offset frontal collisions, this technique may not provide access to the footwell.

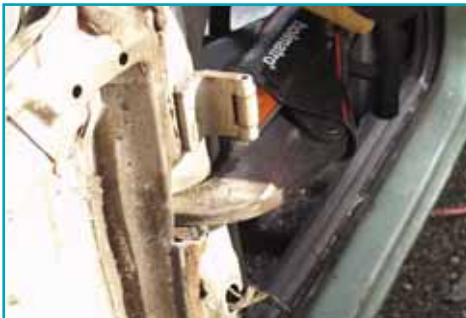

Make two relief cuts approximately 30 cm/12 inches apart in the base of the A pillar.



Pay careful attention to movement of the cutter during this operation to ensure that it does not make contact with the patient or the seat.

Foot well access



Clamp the spreader onto the cut section.



Fold this section outward with the spreader.



Now that access to the foot well is created you may work safely in this area.



ALTERNATIVE:



In some cases it may also be possible to pull pedals away from the patient's feet using a strap to bend the pedals to the side. As seen in the picture, the door may help as a lever to attach the strap to.



Dashboard lift

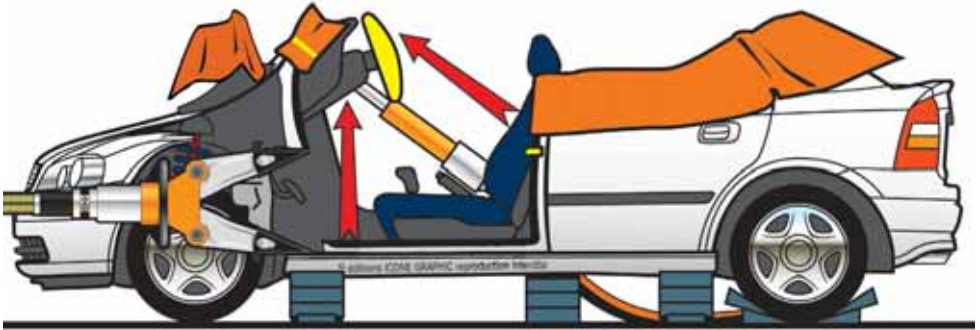

OBJECTIVE:

To displace the dashboard directly upward away from the patient.



SITUATION ASSESSMENT:

This technique is particularly helpful in those situations where the entrapment is caused more by a downward displacement of the dash rather than a rearward movement.

THE PROCEDURE:

After ensuring that the vehicle is stabilized, make sure that the front fender is fully removed as discussed on page 58 for door removal. A further relief cut into the top of the wheel well is also required to act as a hinge point.



Cut an insertion gap for your spreader tips as discussed in foot well access on page 82. Place blocks directly below the A pillar.



Dashboard lift



The spreader tips are placed in the insertion gap and lifting can begin.



Operating simultaneously with the ram, if it is in place, lift the dash slowly, continuously assessing the points of contact between the spreader tips and the vehicle.



If at any time the lifting operation is stopped pay careful attention to the orientation of the control handle when you begin again. Do not accidentally begin to lower the spreader or ram.



A lot of space is now created that will aid in extrication of the patient. The spreader should not be lowered until the patient is totally free of the vehicle.

HEAVY VEHICLES TECHNIQUES



Heavy goods vehicles



OBJECTIVE:

To create an awareness of the key issues and complications associated with heavy goods vehicle rescue.

This edition of Vehicle Extrication Techniques does not go into extensive detail with respect to heavy goods vehicle rescue. It is my hope to cover this topic in more detail in a future edition.



SITUATION ASSESSMENT:

Because these vehicles are designed to transport heavy loads, their design and construction differs significantly from light motor vehicles.

What we have to remember is that heavy goods vehicles are designed for carrying heavy loads and not just a few passengers. This means that very often we have to contend with an immensely strong construction that may require higher capacity rescue tools. The large size and weight of these vehicles can present complicated stabilization problems. Large spaces between the ground and the vehicle, off-center loads, hazardous cargos and odd shapes are some of the complications. It is also important to understand the difference between stabilizing the sprung and un-sprung weight of a heavy goods vehicle. When a heavy goods vehicle is on all of its wheels on level ground it is not complicated. In the event that the vehicle comes to rest on uneven ground, other obstacles or not on its wheels, stabilization becomes highly technical.



Heavy goods vehicles

A further difficulty is the height of the cabins making it necessary to work on ladders or platforms. Safely working on a platform requires practice and a clear understanding between all team members of what is appropriate in terms of handing tools to each other and the eventual removal of the patient over this platform.



Structure of a truck cabin

You will find various models of cabins:

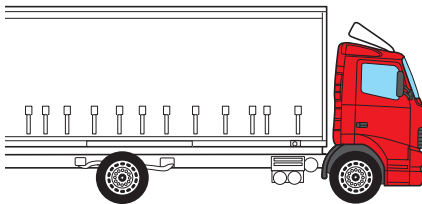

Flat front cabin / Cab over

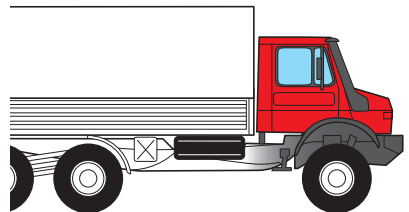

Semi-front cabin / Conventional Cab

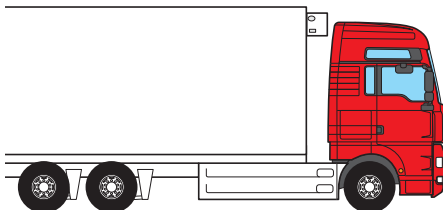

***Flat front cabin with rear sleeping cabin
/ Cab over sleeper***

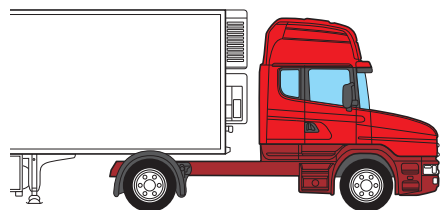

***Semi-front cabin with rear sleeping cabin
/ Conventional with sleeper***

Heavy goods vehicles



Chock the wheels and the cabin; it may be necessary to strap the cabin to the chassis if the locking mechanism is damaged during the impact.



Remove door using hinge exposure techniques where possible. By starting on the hinge side first one will normally find that the door is easily removed after cutting or breaking the hinges.



Be aware of the weight of the door. Support with a tension belt.



Position the ram horizontally at the height of the lock.



Cut the top of the A pillar of the cabin and make relief cuts through the base of the A pillar as well as in the front of the dash area for an isolated frontal dash push.



Heavy goods vehicles



Make a controlled forward dash displacement only enough to remove the entrapped patient.



If required you can push the roof upwards by making relief cuts in both sides and pushing it with a ram.



Glass management should always be performed first as discussed in light motor vehicles along with control of airbag hazards. It may also be beneficial to remove the front windshield to aid in management of the entrapped patient as well as aiding in the extrication process.



In many cases it is greatly beneficial to tilt or push the steering column up. This can often be performed using the vehicle's own column shift system or if required by pushing it away with your tools.

Buses



OBJECTIVE:

To create an awareness of the key issues and complications associated with the disentanglement of patients involved in bus crashes.



SITUATION ASSESSMENT:

Buses are often put in the category of heavy vehicles but have a different construction when compared to trucks. The bus compartment is very vulnerable in the case of an accident. It is positioned on a chassis consisting of longitudinal beams and a criss-cross pattern of pipes welded together on which the outside cover (steel plate or fiberglass) is fixed.

This construction often fails to withstand the forces exerted on it in the event of a crash. This leads to the potential entrapment of large numbers of patients. The seats inside the bus often fail due to the forces of the crash, further entrapping patients.



photo Y.Ebel

The height of the structure can lead to difficult stabilization needs in such an incident.

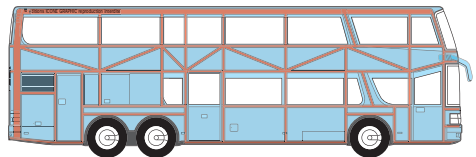
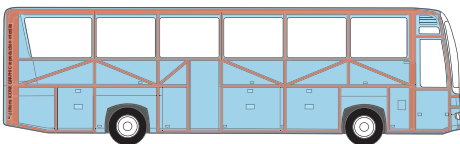

Criss-cross construction of tour buses, one and two story.

Buses



photo : Y. Ebel

Buses do not normally have much structural strength.

GAINING ACCESS:

After the job of stabilization, the task is to gain access into the bus. This can be done in a number of ways, the simplest of which would be to use doors, side windows or emergency exits on the roof. Once you have gained access you will immediately have a far better idea of the magnitude of the incident, as you will be able to tell the number and nature of the injuries sustained to those involved. Do not forget to check the luggage compartments as well as the beds and the toilets if the bus is equipped with these.



detail of the emergency exits

Buses

SCENE MANAGEMENT:

Due to the fact that in most bus incidents there are a large number of patients, it is important to clearly define roles in your rescue team along with clear working zones. It may also be necessary to designate clear emergency vehicle staging areas in order to facilitate rapid patient transport. In certain cases it may be necessary to divide rescue teams into smaller teams working in different areas.



Rescuers working in different sectors.

EXTRICATION OPERATIONS:

Extrication operations on such a bus accident normally consist of creating space for both initial access and patient removal. Once access is gained, you can begin the disentanglement of occupants from between the seats.



Self-contained rescue tools work well in the confined spaces of a bus.

Strategic handling of the operations inside the bus should be focused on maintaining a clear access and egress route for stretcher patients throughout the incident. Developing clear commands between those inside operating tools and those outside operating the pumps also ensures smooth operations. This problem can also be solved with the use of self-contained rescue tools inside the bus.

Acknowledgements

This book would not have been possible without the assistance and valuable input from the following persons and organisations.

For their roles in formulation and discussion of many techniques and strategies described in the book:

- **Robert Walmsley (The Late)**
- **Dave Dalrymple**
- **Al Sergio Sr.**

For their assistance in proof reading and content consultation:

- **Giff Swayne**
- **Tony Barboza**
- **Fran Dunigan**
- **Ad Rombouts**

For technical assistance and photographs:

- **VW**
- **Toyota**
- **BMW**
- **Renault**
- **Honda**
- **Volvo**
- **Holmatro**
- **SAVER Foundation**
- **European New Car Assessment Program**
- **Insurance Institute of Highway Safety**
- **Ron Moore, Plano Fire Department**
- **Major Yves Ebel**

Finally a special word of thanks to all the operational rescuers from around the world, who have shared their personal rescue experiences and expertise with me. Your valuable input is greatly appreciated.



ISBN 2-910725-34-0

éditions
ICONE GRAPHIC

www.iconegraphic.com